

PEDIATRIC SYSTEM

**PEDIATRIC
SYSTEM**

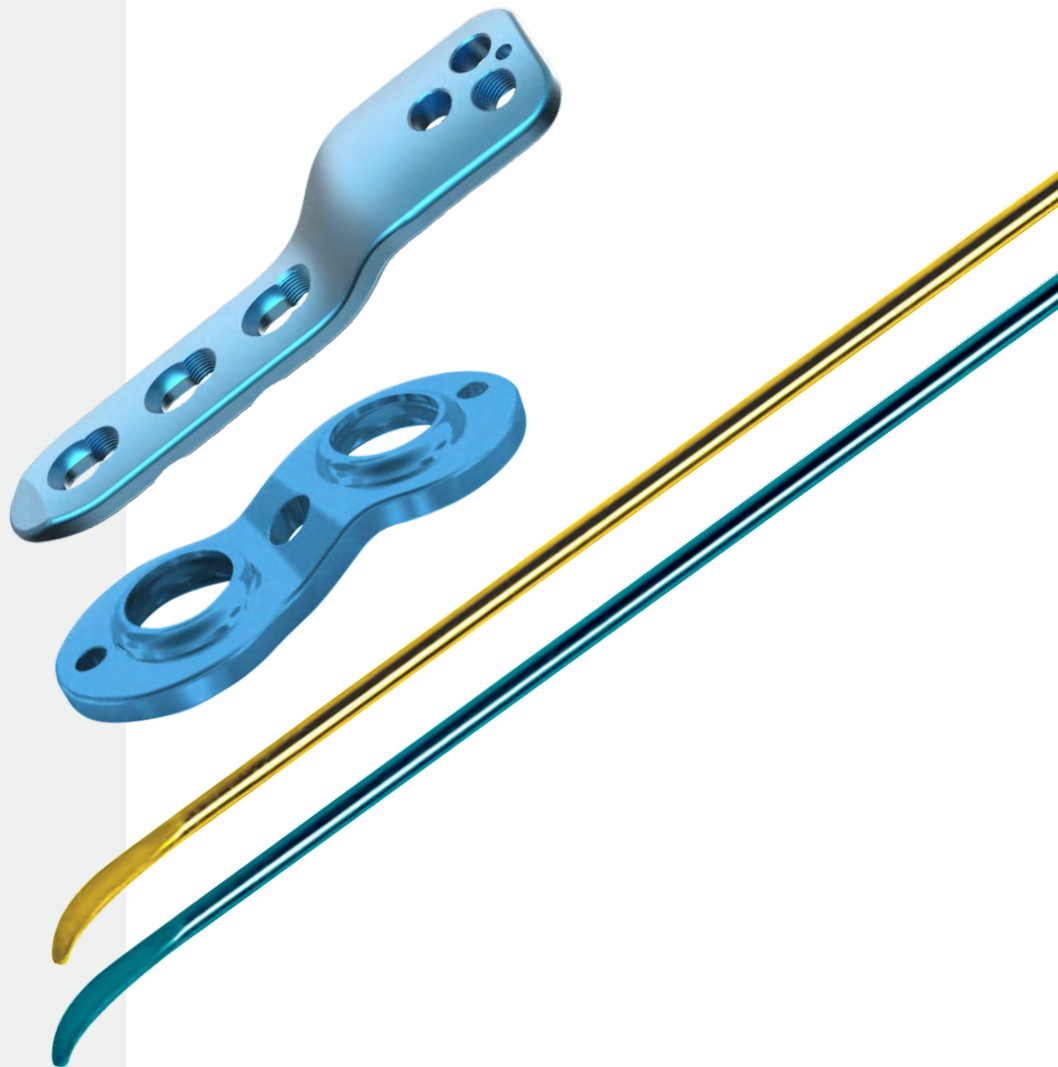

about us

Auxein Medical is an integrated, research based, orthopaedic Implants & Instruments manufacturing company, producing a wide range of quality, affordable generic implants, trusted by healthcare professionals and patients across geographies. It is the Company's constant endeavor to provide a wide basket of generic and innovator products that exceed the highest expectations of our customers in term of quality and safety. The company has world-class manufacturing unit established in India and serves customers in over 60 countries worldwide.

Our Achievements

US FDA 510K APPROVED •

(Locking Plates and Screws)

EC Certificate - Class IIa & IIb •

ISO 13485:2016 •

ISO 9001:2015 •

India FDA Approved •

India MDR 2017 •

Orthopaedic Implants

Index

Epiphyseal Plate System 1-8

Pediatric Hip Plate 9-24

Elastic Nailing System 25-31

Epiphyseal **Plate System**

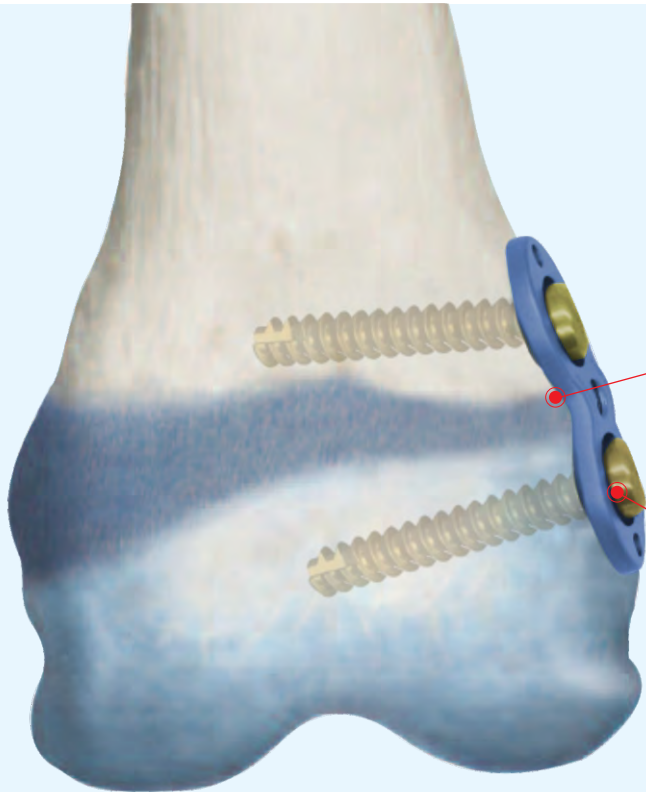

Anatomical pre-contoured plate with excellent fit to patient anatomy.

Kirschner Wire for temporary fixation of the plate.



Low profile for minimized soft tissue irritation.



4.5mm Cortex Screw, Self-tapping, Cannulated

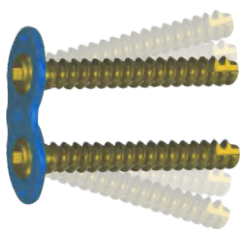

Diverging screws work as a hinge to facilitate physis growth and faster correction .



Cannulated design facilitate the screws inserting orientation with the help of kirschner wire.

Warning

This flyer is just for understanding the specific product features. For clinical usage, please refer to the surgical guide. Instruction by experienced surgeon is highly recommended.

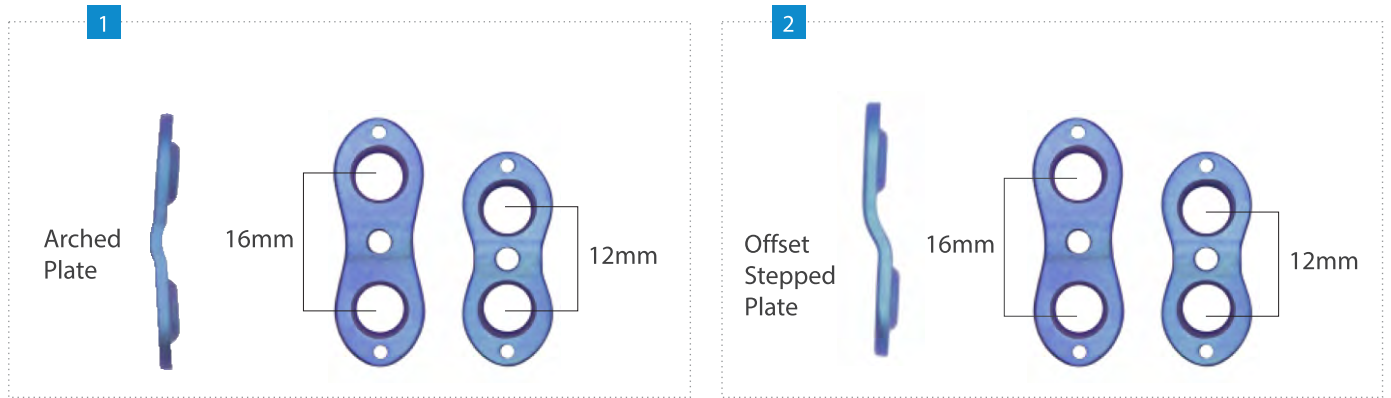

Available in Stepped and Arched Shape, Length 12mm or 16mm, Accommodating Different Patient Anatomies.



Minimally invasive technique facilitates operation and reduces post-surgical pain, allowing immediate mobilization and weight bearing.

Elevated design reduces contact with growth plate and periosteum.

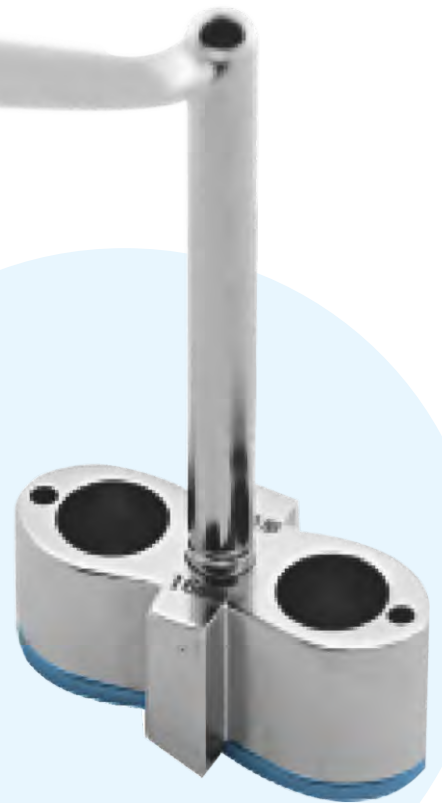

Indications

Gradual correction of pediatric deformities in upper and lower extremities:

- Ankle valgus
- Cubitus varus (post supracondylar fracture)
- Knee valgus, varus, oblique plane, flexion deformity, recurvatum

Epiphyseal Plate

Item Code	Item Name	Length (mm)
EP-001	Epiphyseal Plate, Terrace Shape	12
EP-002	Epiphyseal Plate, Terrace Shape	16
EP-003	Epiphyseal Plate, Arc-Bridge Shape	12
EP-004	Epiphyseal Plate, Arc-Bridge Shape	16

4.5mm Cortex Screw, Self-Tapping, Cannulated, (3.0mm Hex), Titanium

Item Code	Length (mm)
EPS-001	16
* 13-003-018TI	18
EPS-002	20
* 13-003-022TI	22
EPS-003	24
* 13-003-026TI	26
EPS-004	28
* 13-003-030TI	30
EPS-005	32
* 13-003-034TI	34
EPS-006	36
EPS-007	40
* 13-003-045TI	45
* 13-003-050TI	50



13-028 Epiphyseal Plate Implant Set

Item Code	Item Name	Units
EP-001	Epiphyseal Plate, Terrace Shape, Length 12mm, Titanium	1
EP-002	Epiphyseal Plate, Terrace Shape, Length 16mm, Titanium	1
EP-003	Epiphyseal Plate, Arc-Bridge Shape, Length 12mm, Titanium	1
EP-004	Epiphyseal Plate, Arc-Bridge Shape, Length 16mm, Titanium	1
EPS-001	4.5mm Cortex Screw, Self-Tapping, Cannulated, Length 16mm(3.0mm Hex),Titanium	6
EPS-002	4.5mm Cortex Screw, Self-Tapping, Cannulated, Length 20mm(3.0mm Hex),Titanium	6
EPS-003	4.5mm Cortex Screw, Self-Tapping, Cannulated, Length 24mm(3.0mm Hex),Titanium	6
EPS-004	4.5mm Cortex Screw, Self-Tapping, Cannulated, Length 28mm(3.0mm Hex),Titanium	6
EPS-005	4.5mm Cortex Screw, Self-Tapping, Cannulated, Length 32mm(3.0mm Hex),Titanium	6
EPS-006	4.5mm Cortex Screw, Self-Tapping, Cannulated, Length 36mm(3.0mm Hex),Titanium	6
EPS-007	4.5mm Cortex Screw, Self-Tapping, Cannulated, Length 40mm(3.0mm Hex),Titanium	6
7-040-01	Implant Box for Epiphyseal Plate System	1

EPI-001 Aiming Device, Terrace Shape, Small



EPI-002 Aiming Device, Terrace Shape, Large



EPI-003 Aiming Device, Arc-Bridge Shape, Small



EPI-004 Aiming Device, Arc-bridge Shape, Large



EPI-005 Handle for Aiming Device



EPI-006 Cannulated Fixation Bolt, Ø1.5/3.0mm



EPI-007

Guide Wire, Ø1.5 x Length 150mm

**EPI-008**

Wire Sleeve, Ø1.5mm

**EPI-009**

Depth Gauge measuring upto 50mm

**EPI-010**

Protection Sleeve for Drill Guide Ø6.1/ 7.3mm

**EPI-011**

Drill Bit Ø3.0mm, Cannulation Ø1.5mm, Length 200mm

**EPI-018**

Stopper for Cannulated Drill Bit Ø3.0mm



EPI-012 Drill Sleeve for Ø3.0mm Drill Bit



EPI-014 Screw Forcep for Epiphyseal Plate System



EPI-015 Screwdriver, Hexagonal, Cannulated Ø3.0mm



EPI-016 Allen key, Hex 2.5mm



7-040-01 Implant Box for Epiphyseal Plate Implant Set



EPI-017 Container for Epiphyseal Plate Instrument Set

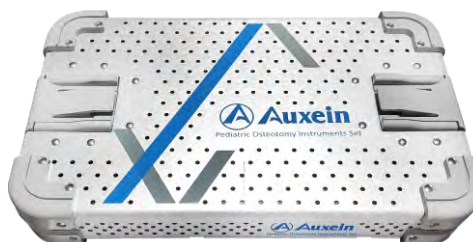

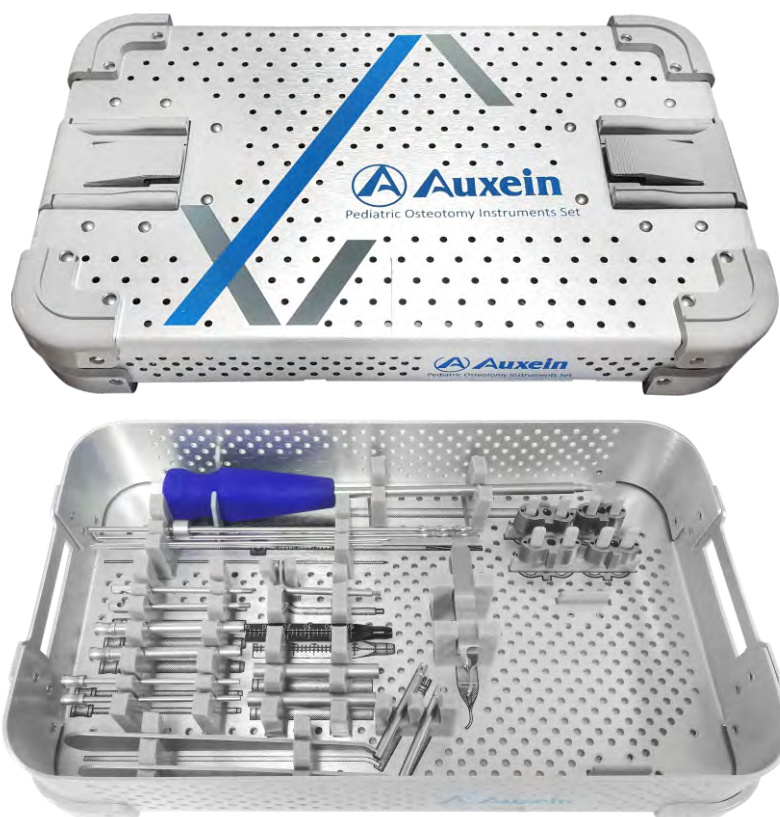
INS-EPS Epiphyseal Plate Instrument Set

Item Code	Item Name	Unit
EPI-001	Aiming Device, Terrace Shape, Small	1
EPI-002	Aiming Device, Terrace Shape, Large	1
EPI-003	Aiming Device, Arc-Bridge Shape, Small	1
EPI-004	Aiming Device, Arc-bridge Shape, Large	1
EPI-005	Handle for Aiming Device	2
EPI-006	Cannulated Fixation Bolt, Ø1.5/ 3.0mm	2
EPI-007	Guide Wire, Ø1.5 x Length150mm	3
EPI-008	Wire Sleeve, Ø1.5mm	2
EPI-009	Depth Gauge measuring upto 50mm	1
EPI-010	Protection Sleeve for Drill Guide Ø6.1/7.3mm	2
EPI-011	Drill Bit Ø3.0mm, Cannulation Ø1.5mm, Length 200mm	2
EPI-018	Stopper for Cannulated Drill Bit Ø3.0mm	1
EPI-012	Drill Sleeve for Ø3.0mm Drill Bit	2
EPI-014	Screw Forcep for Epiphyseal Plate System	1
EPI-015	Screwdriver, Hexagonal, Cannulated Ø3.0mm	1
EPI-016	Allen key, Hex 2.5mm	1
7-040-01	Implant Box for Epiphyseal Plate Implant Set	1
EPI-017	Container for Epiphyseal Plate Instrument Set	1

Pediatric Hip **Plate System**

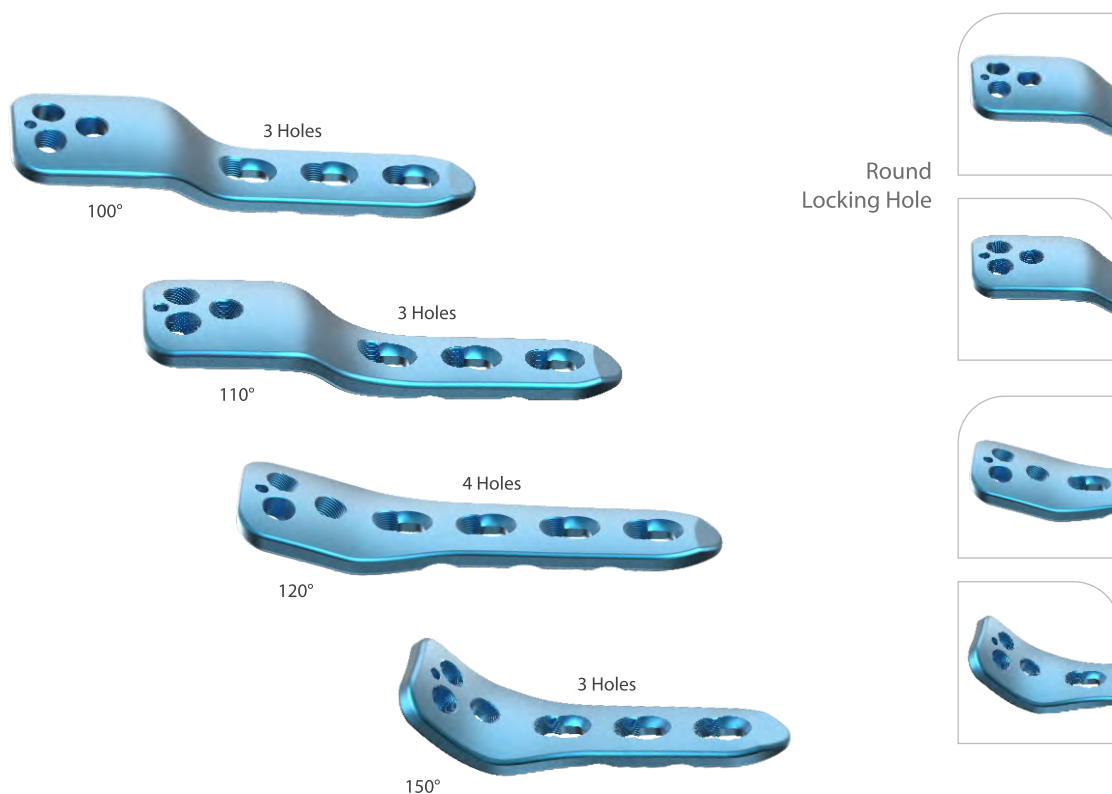
3.5mm Wise-Lock Paediatric Hip Plate

Degree	Length	Holes	Width	Stainless Steel	Titanium
90°	75mm	3	18.5mm	1121.090	TI-1121.090
100°	75mm	3	18.5mm	1121.100	TI-1121.100
110°	75mm	3	18.5mm	1121.110	TI-1121.110
120°	75mm	4	18.5mm	1121.120	TI-1121.120
150°	60mm	3	18.5mm	1121.150	TI-1121.150

4.5/5.0mm Wise-Lock Paediatric Hip Plate

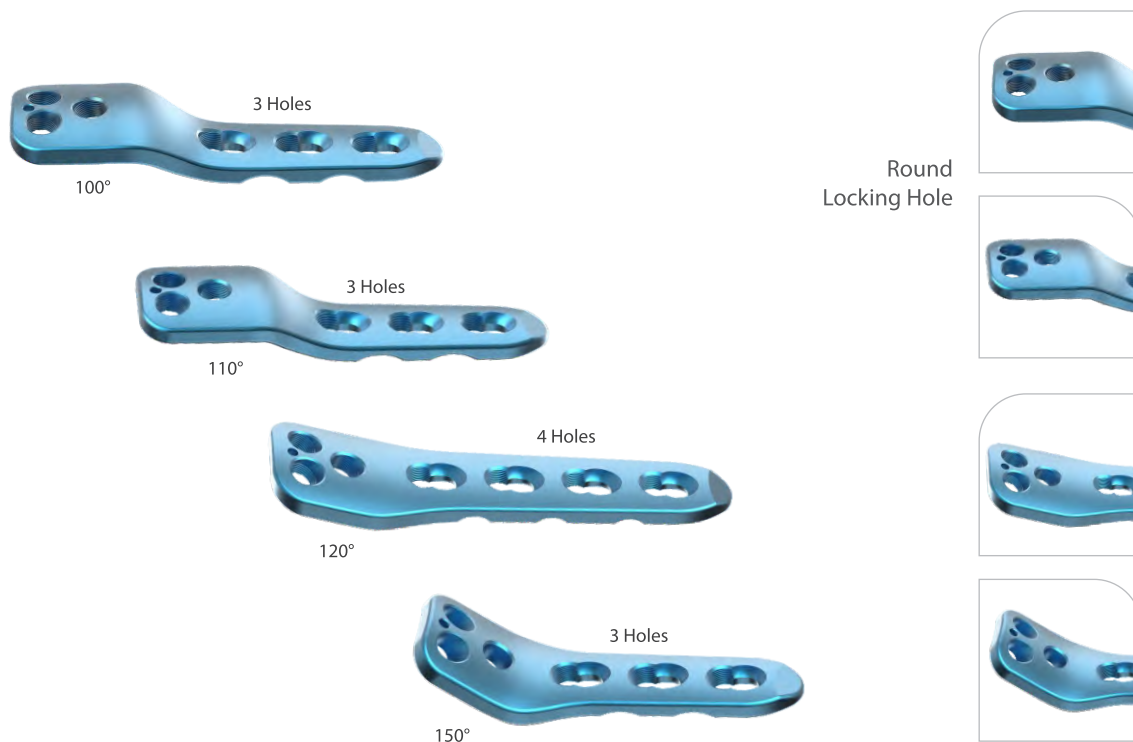

Degree	Length	Holes	Width	Stainless Steel	Titanium
90°	90mm	3	22.5mm	1122.090	TI-1122.090
100°	90mm	3	22.5mm	1122.100	TI-1122.100
110°	90mm	3	22.5mm	1122.110	TI-1122.110
120°	95mm	4	22.5mm	1122.120	TI-1122.120
150°	75mm	3	22.5mm	1122.150	TI-1122.150

3.5mm Wise-Lock Screw, Self-Tapping, (Hex Head)

Length (mm)	Stainless Steel	Titanium
10	117.010	TI-117.010
12	117.012	TI-117.012
14	117.014	TI-117.014
16	117.016	TI-117.016
18	117.018	TI-117.018
20	117.020	TI-117.020
22	117.022	TI-117.022
24	117.024	TI-117.024
26	117.026	TI-117.026
28	117.028	TI-117.028
30	117.030	TI-117.030
32	117.032	TI-117.032
34	117.034	TI-117.034
35	117.035	TI-117.035
36	117.036	TI-117.036
38	117.038	TI-117.038
40	117.040	TI-117.040
42	117.042	TI-117.042
44	117.044	TI-117.044
45	117.045	TI-117.045
46	117.046	TI-117.046
48	117.048	TI-117.048
50	117.050	TI-117.050
52	117.052	TI-117.052
54	117.054	TI-117.054
55	117.055	TI-117.055
56	117.056	TI-117.056
58	117.058	TI-117.058
60	117.060	TI-117.060
65	117.065	TI-117.065
70	117.070	TI-117.070
75	117.075	TI-117.075
80	117.080	TI-117.080



3.5mm Cortical Screw, Self-Tapping, (Hex Head)

Length (mm)	Stainless Steel	Titanium
10	104.210	TI-104.210
12	104.212	TI-104.212
14	104.214	TI-104.214
16	104.216	TI-104.216
18	104.218	TI-104.218
20	104.220	TI-104.220
22	104.222	TI-104.222
24	104.224	TI-104.224
26	104.226	TI-104.226
28	104.228	TI-104.228
30	104.230	TI-104.230
32	104.232	TI-104.232
34	104.234	TI-104.234
36	104.236	TI-104.236
38	104.238	TI-104.238
40	104.240	TI-104.240
42	104.242	TI-104.242
44	104.244	TI-104.244
46	104.246	TI-104.246
48	104.248	TI-104.248
50	104.250	TI-104.250
55	104.255	TI-104.255
60	104.260	TI-104.260
65	104.265	TI-104.265
70	104.270	TI-104.270
75	104.275	TI-104.275
80	104.280	TI-104.280
85	104.285	TI-104.285
90	104.290	TI-104.290



4.5mm Cortical Screw, Self-Tapping, (Hex Head)

Length (mm)	Stainless Steel	Titanium
20	105.220	TI-105.220
22	105.222	TI-105.222
24	105.224	TI-105.224
26	105.226	TI-105.226
28	105.228	TI-105.228
30	105.230	TI-105.230
32	105.232	TI-105.232
34	105.234	TI-105.234
36	105.236	TI-105.236
38	105.238	TI-105.238
40	105.240	TI-105.240
42	105.242	TI-105.242
44	105.244	TI-105.244
46	105.246	TI-105.246
48	105.248	TI-105.248
50	105.250	TI-105.250
52	105.252	TI-105.252
54	105.254	TI-105.254
55	105.255	TI-105.255
56	105.256	TI-105.256
58	105.258	TI-105.258
60	105.260	TI-105.260
65	105.265	TI-105.265
70	105.270	TI-105.270
80	105.280	TI-105.280
85	105.285	TI-105.285
90	105.290	TI-105.290



5.0mm Wise-Lock Screw, Self-Tapping, (Hex Head)

Length (mm)	Stainless Steel	Titanium
12	119.012	TI-119.012
14	119.014	TI-119.014
16	119.016	TI-119.016
18	119.018	TI-119.018
20	119.020	TI-119.020
22	119.022	TI-119.022
24	119.024	TI-119.024
26	119.026	TI-119.026
28	119.028	TI-119.028
30	119.030	TI-119.030
32	119.032	TI-119.032
34	119.034	TI-119.034
36	119.036	TI-119.036
38	119.038	TI-119.038
40	119.040	TI-119.040
42	119.042	TI-119.042
44	119.044	TI-119.044
46	119.046	TI-119.046
48	119.048	TI-119.048
50	119.050	TI-119.050
52	119.052	TI-119.052
54	119.054	TI-119.054
56	119.056	TI-119.056
58	119.058	TI-119.058
60	119.060	TI-119.060
65	119.065	TI-119.065
70	119.070	TI-119.070
75	119.075	TI-119.075
80	119.080	TI-119.080
85	119.085	TI-119.085
90	119.090	TI-119.090



1471-01 Guide Wire, Ø2.0mm x Thread Length 7.5mm x Length 150mm



1471-02 Positioner for Aiming Block



1471-03 Aiming Block, Ø3.5mm



1471-04 Aiming Block, Ø5.0mm



1471-05 Guide Wire, Ø2.8mm x Length 200mm



1471-06 Positioner for Osteotomy



1471-07 Reduction Forcep, Serrated Jaw, Curved



1471-08 LCP Drill Sleeve, Ø2.8mm



1471-09 LCP Drill Sleeve, Ø4.3mm



1471-10 Reduction Sleeve, Ø4.3/2.8mm



1471-11 Depth Gauge, Ø2.8 mm



1471-13 Screwdriver, Hex 2.5mm

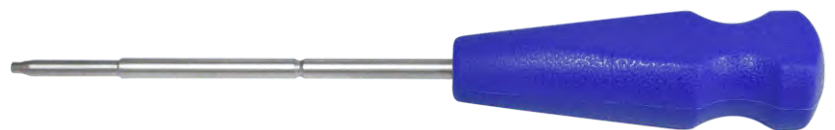

1471-13S Holding Sleeve for Screwdriver, Hex2.5mm



1471-15 Screwdriver, Hex 3.5mm



1471-15S Holding Sleeve for Hexagonal Screwdriver, Hex3.5mm



1471-16 Screwdriver Shaft, Hex 2.5mm



1471-17 Screwdriver Shaft, Hex 3.5mm



1471-18 T Handle with Quick Coupling

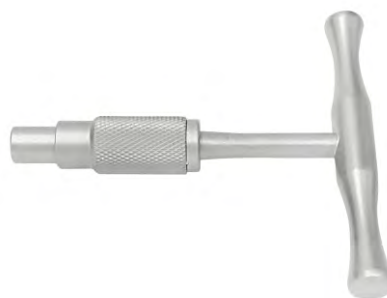

1471-21 Torque Limiting Screwdriver, 4.0 Nm, Hex 3.5mm



1471-21S Holding Sleeve for Torque Limiting Screwdriver, 4.0 Nm



1471-22 Torque Limiting Screwdriver, 1.5 Nm, Hex 2.5mm



1471-22S Holding Sleeve for Torque Limiting Screwdriver, 1.5 Nm



1471-23 Drill Bit Ø2.5mm x Length 112mm



1471-24 Drill Bit Ø2.8mm x Length 160mm



1471-25 Drill Bit Ø3.2mm x Length 147mm



1471-26 Drill Bit Ø4.3mm x Length 230mm



1471-27 Stopper for Drill Bit, Ø2.8mm



1471-28 Stopper for Drill Bit, Ø4.3mm



1471-29 Depth Gauge measuring upto 60mm



1471-30 Depth Gauge measuring upto 100mm



1471-31 Bone Holding Forcep, Self-Centering



1471-32 Double Drill Guide, Ø2.5/3.5mm



1471-33 Double Drill Guide, Ø3.2/4.5mm



1471-34 Tap, HA3.5mm



1471-35 Tap, HA4.5mm



1471-36 Positioning Plate, Triangular, 90°/50°/40°

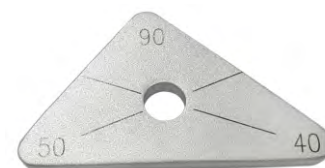

1471-37 Positioning Plate, Triangular, 80°/70°/30°



1471-38 Positioning Plate, Triangular, 100°/60°/20°



1471-39 Instrument for Medialization



1471-41 Trays for Pediatric Hip Plate Instrument Set

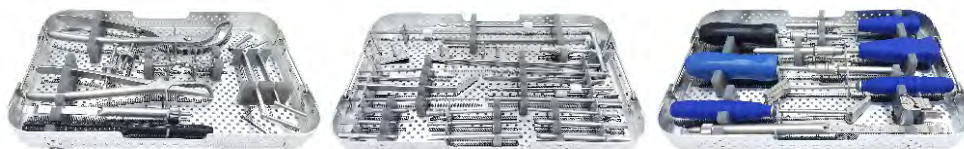

1471-40 Container with PPSU lid for Pediatric Hip Plate Instrument Set



INS-1471-000 Pediatric Hip Instrument Set

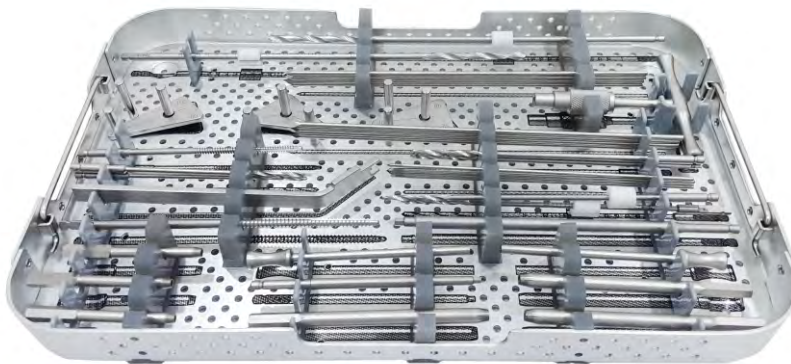
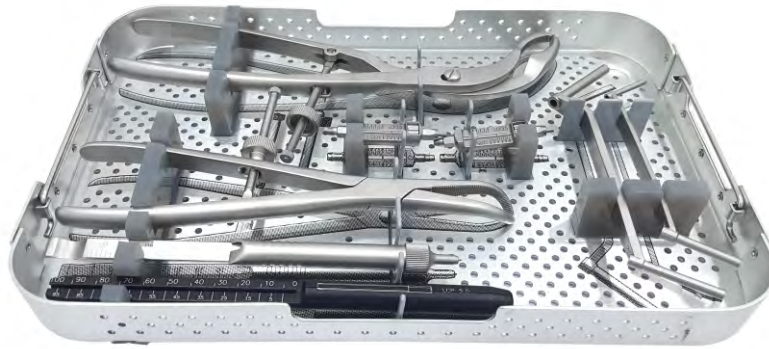
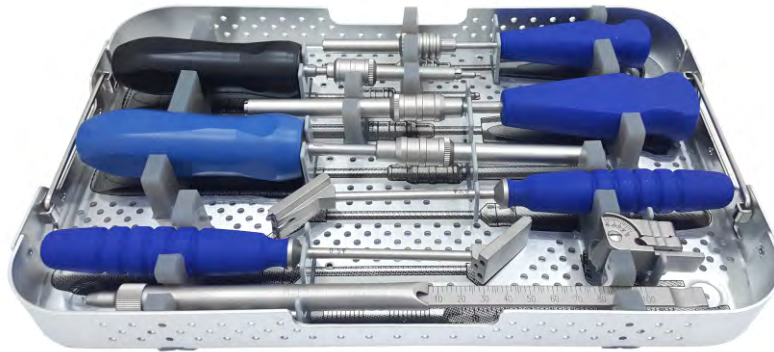

INS-1471-000 Pediatric Hip Instrument Set

Code	Set Consisting of	Units
1471-01	Guide Wire, Ø2.0 x Thread Length 7.5mm x Length 150mm	4
1471-02	Positioner for Aiming Block	1
1471-03	Aiming Block, Ø3.5mm	1
1471-04	Aiming Block, Ø5.0mm	1
1471-05	Guide Wire, Ø2.8mm x Length 200mm	8
1471-06	Positioner for Osteotomy	1
1471-07	Reduction Forcep, Serrated Jaw, Curved	1
1471-08	LCP Drill Sleeve, Ø2.8mm	3
1471-09	LCP Drill Sleeve, Ø4.3mm	3
1471-10	Reduction Sleeve, Ø4.3/2.8mm	2
1471-11	Depth Gauge, Ø2.8 mm	1
1471-13	Screwdriver, Hex 2.5mm	1
1471-13S	Holding Sleeve for Screwdriver, Hex2.5mm	1
1471-15	Screwdriver, Hex 3.5mm	1
1471-15S	Holding Sleeve for Hexagonal Screwdriver, Hex3.5mm	1
1471-16	Screwdriver Shaft, Hex 2.5mm	1
1471-17	Screwdriver Shaft, Hex 3.5mm	1
1471-18	T Handle with Quick Coupling	1
1471-21	Torque Limiting Screwdriver, 4.0 Nm, Hex 3.5mm	1
1471-21S	Holding Sleeve for Torque Limiting Screwdriver, 4.0 Nm	1
1471-22	Torque Limiting Screwdriver, 1.5 Nm, Hex 2.5mm	1
1471-22S	Holding Sleeve for Torque Limiting Screwdriver, 1.5 Nm	1
1471-23	Drill Bit Ø2.5mm x Length 112mm	2
1471-24	Drill Bit Ø2.8mm x Length 160mm	2
1471-25	Drill Bit Ø3.2mm x Length 147mm	2
1471-26	Drill Bit Ø4.3mm x Length 230mm	2
1471-27	Stopper for Drill Bit, Ø2.8mm	2
1471-28	Stopper for Drill Bit, Ø4.3mm	2
1471-29	Depth Gauge measuring upto 60mm	1
1471-30	Depth Gauge measuring upto 100mm	1
1471-31	Bone Holding Forcep, Self-Centering	1
1471-32	Double Drill Guide, Ø2.5/3.5mm	1
1471-33	Double Drill Guide, Ø3.2/4.5mm	1
1471-34	Tap, HA3.5mm	1

Code	Set Consisting of	Units
1471-35	Tap, HA4.5mm	1
1471-36	Positioning Plate, Triangular, 90°/50°/40°	1
1471-37	Positioning Plate, Triangular, 80°/70°/30°	1
1471-38	Positioning Plate, Triangular, 100°/60°/20°	1
1471-39	Instrument for Medialization	2
1471-41	Instrument Trays for Pediatric Hip Plate Instrument Set	3
1471-40	Container for PPSU lid for Pediatric Hip Plate Instrument Set	1

Elastic

Nailing System

Titanium Elastic Nail



Size					
Ø1.5mm x 440mm	Ø2.0mm x 440mm	Ø2.5mm x 440mm	Ø3.0mm x 440mm	Ø3.5mm x 440mm	Ø4.0mm x 440mm
Code					
412-1.5-044	412-2.0-044	412-2.5-044	412-3.0-044	412-3.5-044	412-4.0-044

End Cap for Titanium Elastic Nail

Size	
Ø3.0mm-4.0mm	Ø1.5mm-2.5mm
Code	
412E-1C	412E-2C



2101-2.7-125 Drill Bit Plain Shank/Jacob Chuck End, Ø2.7mm x Length 125mm



2100-3.2-145 Drill Bit Quick Coupling End, Ø3.2mm x Length 145mm



2100-4.5-145 Drill Bit Quick Coupling End, Ø4.5mm x Length 145mm



3441-01 Impactor for Elastic Nail, Straight



3441-02 Impactor for Elastic Nail, Beveled



3441-03 Insertor for Elastic Nail



3441-04 Awl, Curved Length 180mm, For Clavicular Fractures



3441-06 F-Tool for Reduction - Small



3441-17 Adjustable Reductor

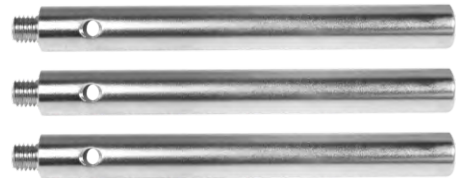

3441-10 Plier for Elastic Nail



3767-4.5 Double Drill Guide 4.5/3.2mm



1243-000 Cutter for Elastic Nail



3441-18 Rotatable Wrench (For Cutter)



3441-11 Hammer



3441-12 Sliding Hammer



3441-13 Pin Wrench, Ø4.5mm



3441-14 Awl



3441-16 Driver for End Cap



7-027-01

Hammer Guide

**7-027-02**

Triangle Wrench for End Cap, Large

**3441-15**

Triangle Wrench for End Cap, Small

**3442-02**

Case for End Cap

**3442-03**

Trays for Elastic Nailing Instrument Set

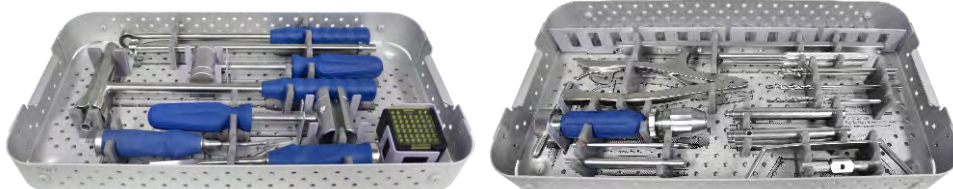
**A10-028**

Container for Elastic Nailing Instrument Set

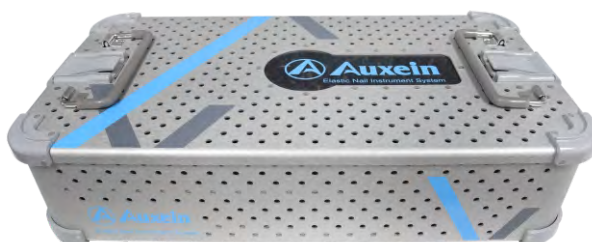

5002-000 Elastic Nailing Instrument Set



5002-000 Elastic Nailing Instrument Set

Codes	Set Consisting of:	Units
2101-2.7-125	Drill Bit Plain Shank/Jacob Chuck End, Ø2.7mm x Length 125mm	2
2100-3.2-145	Drill Bit Quick Coupling End, Ø3.2mm x Length 145mm	2
2100-4.5-145	Drill Bit Quick Coupling End, Ø4.5mm x Length 145mm	2
3441-01	Impactor for Elastic Nail, Straight	1
3441-02	Impactor for Elastic Nail, Beveled	1
3441-03	Insertor for Elastic Nail	1
3441-04	Awl, Curved Length 180mm, for Clavicular Fractures	1
3441-06	F-Tool for Reduction - Small	1
3441-17	Adjustable Reductor	3
3441-10	Plier for Elastic Nail	1
3767-4.5	Double Drill Guide 4.5/3.2mm	1
1243-000	Cutter for Elastic Nail	1
3441-18	Rotatable Wrench (For Cutter)	1
3441-11	Hammer	1
3441-12	Sliding Hammer	1
3441-13	Pin Wrench, Ø4.5mm	1
3441-14	Awl	1
3441-16	Driver for End Cap	1
7-027-01	Hammer Guide	1
7-027-02	Triangle Wrench for End Cap, Large	1
3441-15	Triangle Wrench for End Cap, Small	1
3442-02	Case for End Cap	1
3442-03	Trays for Elastic Nailing Instrument Set	2
A10-028	Container for Elastic Nailing Instrument Set	1



USA

Auxein Inc.
1500 Nw 89th Court, Suite 205,
Doral, Florida 33172
Tel: +1 305 395 6062
E Fax: +1 305 395 6262
Email: USoffice@auxein.com

MEXICO

Auxein México, S.A. de C.V.
Tepic 139 int 801, Colonia Roma Sur,
Alcaldía Cuauhtémoc, CDMX,
México, C.P. 06760
Tel: +521 55 7261 0318
Email: info@auxein.mx

INDIA

Auxein Medical Pvt. Ltd.
Plot No. 168-169-170, Phase-4,
Kundli Industrial Area,
HSIIDC, Sector-57, Sonapat - 131028, Haryana
Tel: +91 99106 43638 | Fax: +91 86077 70197
Email: info@auxein.com